

**MiTek**<sup>®</sup>

# ROOF & FLOOR TRUSSES

A Manual for Architects  
and Engineers

**DESIGN INFORMATION**

**TECHNICAL DATA**

**APPROVALS**

**SPECIFICATION  
& DETAILS**



[www.mitek-us.com](http://www.mitek-us.com)

# MITEK<sup>®</sup> PRODUCTS & SERVICES

**Headquartered in St. Louis, Missouri, MiTek Industries, Inc. is the leading supplier of connector plates, truss manufacturing equipment, design software and engineering services for the worldwide component industry.**



**For more than 35 years MiTek companies have developed and refined their connector plates into the state-of-the-art products they are today... consistent and dependable!**

**With MiTek you're assured of the best quality. MiTek connector plates are manufactured under strict quality control and undergo extensive testing in our R & D facility.**

**MiTek's connector plates meet or exceed all building code and industry association requirements. Acceptances include ICC-ES, Florida-Dade County and LA City.**

**MiTek also offers the very best in framing layout and engineering software for roof and floor trusses, as well as wall panel design. These programs provide our fabricators with fast and accurate layout and design capabilities.**

**Our engineering department is available to review and seal our customers' designs. With offices in North Carolina, Missouri, Florida and California, MiTek's professional engineers can furnish sealed engineering for all 50 states!**

**Look to a MiTek fabricator for the best the industry has to offer! This brochure reviews the benefits of using wood roof and floor trusses, but MiTek fabricators also offer a full line of builders hardware and a complement of other building components including wall panels and steel framing.**

**At MiTek, we are committed to providing the best products and services in the industry and will continue our tradition of customer support.**



CONNECTOR  
PLATES

BRACING &  
RESTRAINING  
PRODUCTS

TRUSS  
MANUFACTURING  
EQUIPMENT

DESIGN  
SOFTWARE

ENGINEERING  
SERVICES



# WHY USE WOOD TRUSSES?

## CONTRACTORS AND BUILDERS KNOW.

### TABLE OF CONTENTS

- 1 | OVERVIEW
- ADVANTAGES**
- 2 | WHY USE WOOD TRUSSES?
- INSTALLATION**
- 4 | HANDLING, INSTALLATION AND BRACING
- PRODUCTS**
- 5 | BRACING & RESTRAINING
- TRUSS TYPES**
- 6 | TYPICAL TYPES
- CONSTRUCTION DETAILS**
- 8 | FLOOR TRUSSES
- 10 | CANTILEVERS, JACKS
- 11 | STAIRWAYS AND STAIRWELLS
- MISCELLANEOUS**
- 12 | ARCHITECTURAL SPECIFICATIONS
- 12 | CONSTRUCTION DOs & DON'Ts
- 12 | RECOMMENDATIONS AND LIMITATIONS
- 13 | CONCENTRATED LOADS
- 14 | CODE APPROVALS
- 14 | FLOOR DECKING
- 14 | MECHANICAL SERVICE CLEARANCES
- 15 | FIRE RATING
- 18 | APPLIED LOADS
- 18 | MATERIAL WEIGHTS
- 17 | SOUND TRANSMISSION
- 19 | MAXIMUM SPANS
- 20 | GLOSSARY

**Contractors and builders know that a MiTek engineered roof or floor truss ensures quality and efficiency.**

#### MiTek Trusses Save Money

Because costs are known in advance, there's no guesswork. Your site erection time is greatly reduced and dollar losses from job site material shortages and pilferage are eliminated.

#### MiTek Trusses Are Reliable

Every MiTek truss has been individually designed and that design is checked and approved by licensed engineers for structural adequacy.

#### MiTEK TRUSSES Are Versatile

MiTek trusses provide more design flexibility, inside and out, than conventional framing. Offering numerous custom design options, our trusses present an economical and structurally superior method for rapid erection.





## FOR THE HOMEOWNER

- ✓ Lower construction costs
- ✓ Clearspan flexibility
- ✓ More flexibility in architectural appearance and floor plans
- ✓ Easier remodeling possibilities in moving interior walls

# ADVANTAGES OF TRUSSES OVER CONVENTIONAL FRAMING

## For Architects/Developers

- Savings in design costs-one basic structural design for shell with minor floor plan variations
- Better project cost control, with component costs known in advance
- Better cash flow with earlier occupancy due to reduced on-site labor
- Faster shell completion time
- Using trusses of smaller dimension lumber, in place of beams and columns
- Greater flexibility in locating plumbing, duct work, and electrical wiring
- Floor plan freedom in locating interior partitions often without additional support required

## For Contractors/Builders

- Pre-determined, pre-engineered truss system
- Fewer pieces to handle and reduced installation time
- Wide 3-1/2" nailing surface for easy floor deck application
- Eliminate notching and boring joists for electrical wiring and plumbing
- Floor trusses offer better availability and less in-place cost than 2x8 or 2x10 joists
- Factory-manufactured components to exact span requirements
- Reduced HVAC, plumbing, and electrical subcontractor time on job
- No column pads to pour, no steel beams and posts to place
- Job site material pilferage and cutting waste reduced





# HANDLING, INSTALLATION AND BRACING\*

\* Reprinted from the "Commentary & Recommendation for Handling, Installing & Bracing, Metal Plate Connected Wood Trusses, HIB-91", by permission of Truss Plate Institute, Inc.

## TEMPORARY BRACING

Temporary or installation bracing is the responsibility of the installer. Temporary bracing should remain in place as long as necessary for the safe and acceptable completion of the roof or floor and may remain in place after permanent bracing is installed.

It is the responsibility of the installer to select the most suitable method and sequence of installation available to him which is consistent with the owner's (architectural) plans and specifications and such other information which may be furnished to him prior to installation. Trusses may be installed either by hand or by mechanical means. The method generally depends upon the span of the trusses, their installed height above grade, and/or the accessibility or availability of mechanical installation equipment (such as a crane or forklift).

The installer should be knowledgeable about the truss design drawings, truss placement plans, and all notes and cautions thereon.



## FIELD ASSEMBLY

In some cases, the size or shape of wood trusses is such that some field assembly is required. The installer is responsible for proper field assembly.

Complete details can be found in the *Building Component Safety Information Guide to Good Practice for Handling, Installing, Restraining and Bracing of Metal Plate Connected Wood Trusses*, available through SBCA (Structural Building Components Association) and TPI (Truss Plate Institute).

## STORAGE

Trusses should be stored in a stable position to prevent toppling and/or shifting.

If trusses are stored horizontally, the blocking should be eight to ten foot centers to prevent lateral bending. If the truss bundle is to be stored for more than one week, the solid-blocking, generally provided by the receiving party, should be at a sufficient height to lessen moisture gain from the ground.

During long-term storage, trusses should be protected from the elements in a manner that provides for adequate ventilation of the trusses. If tarpaulins or other water resistant materials are used, the ends should be left open for ventilation. If trusses are made with interior rated fire retardant lumber, extreme care should be taken to limit outside exposure.

# MITEK® BRACING AND RESTRAINING PRODUCTS



## FEATURES

## STABILIZER®

### Temporary & permanent lateral bracing

The **Stabilizer**® accurately spaces roof trusses on 24" and 16" centers with an accuracy of 1/32". It provides lateral restraints and remains as a permanent lateral restraint. The Stabilizer installs as fast as the crane can set trusses and clips on to ride up with the truss to the plate line.

Most importantly the Stabilizer saves time and money. It can reduce installation time by 45 percent and crane expense by 35 percent. It completely eliminates the time spent cutting temporary bracing lumber and de-nailing and disposing of temporary bracing.



*The Stabilizer spaces and braces in one step with just a hammer.*

- ✓ Save time and money
- ✓ Eliminate spacing errors
- ✓ The Stabilizer spaces and braces in one step with just a hammer

## MULTI-BRACE™

### All-purpose permanent brace

The **MiTek**® **Multi-Brace**™ is the all-purpose brace that satisfies virtually all of your permanent truss bracing requirements, yet installs more quickly without adding costs. The ultra light Multi-Brace delivers simple shipping, handling on the ground and in the roof system - assuring you of a safe and accurately braced roof system.

Its unique nesting feature allows for substantial material savings since it does not require the customary one truss or 24" overlap of conventional lumber bracing.

*MiTek Multi-Brace, the all purpose brace.*

## ELIMINATOR®

### Factory-installed T-Bracing

Speed up roof framing and eliminate field-applied compression web bracing with MiTek's **Eliminator**™. Eliminator is the factory-installed alternative to field-applied T-bracing and is engineered by **MiTek**® **20/20**® software.

You can get peace of mind and an engineered component when the T-bracing is installed by your component manufacturer in their plant. T-bracing, installed in the right places, can reduce your web bracing problems before they occur.

The Eliminator is the engineered solution to T-bracing installation. It can reduce labor costs and call backs while improving job safety.



- ✓ Factory-installed, engineered web bracing

*Eliminator builds a better roof system.*





# TRUSS TYPES

## Basic Roof Truss Configurations

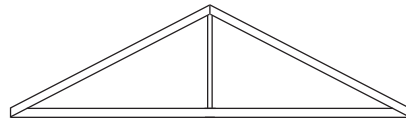

**KINGPOST**

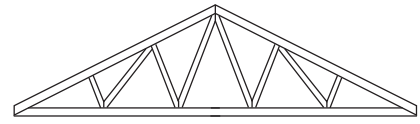

**DOUBLE FINK**

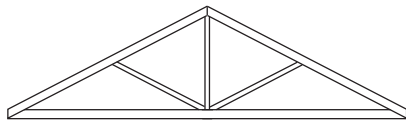

**QUEENPOST**

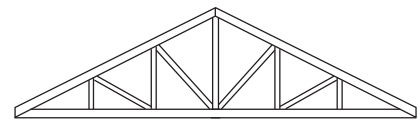

**DOUBLE HOWE**

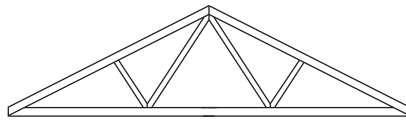

**FINK**

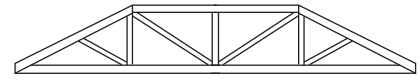

**HIP**

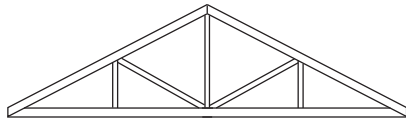

**HOWE**

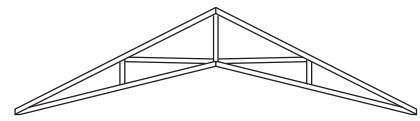

**SCISSORS**

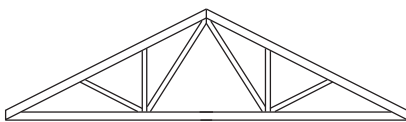

**FAN**

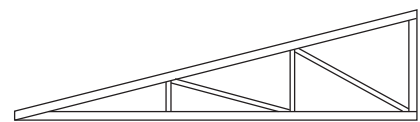

**MONOPITCH**

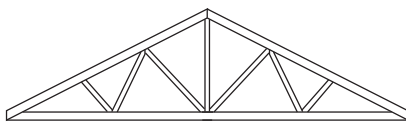

**MODIFIED QUEENPOST**

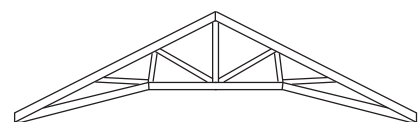

**CAMBERED**





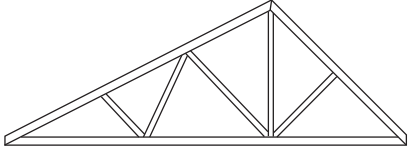

**DUAL PITCH**

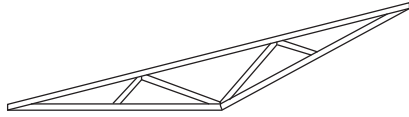

**INVERTED**

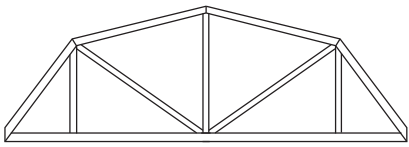

**GAMBREL**

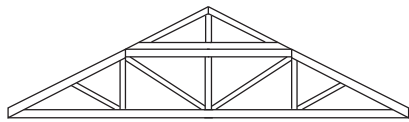

**PIGGYBACK**

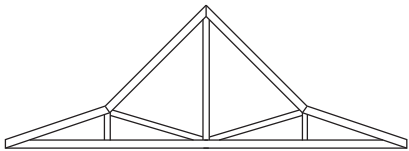

**POLYNESIAN**

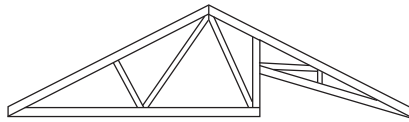

**STUDIO**

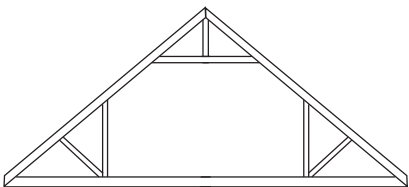

**ATTIC**

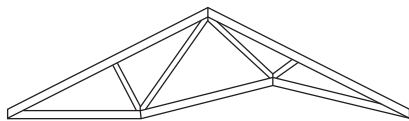

**CATHEDRAL**

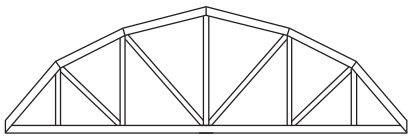

**BOWSTRING**

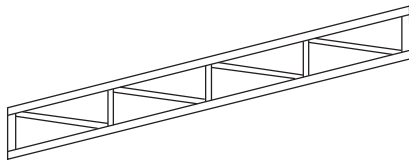

**SLOPING FLAT**

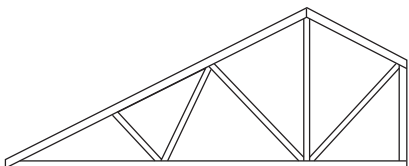

**STUB**

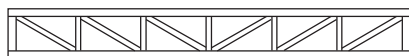

**FLAT**





# FLOOR TRUSS CONSTRUCTION DETAILS

## Support Details

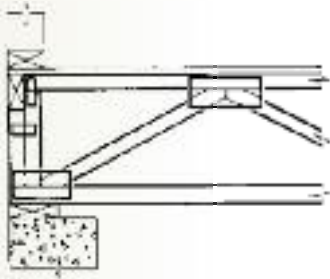

**Bottom Chord Bearing on Exterior Frame or Masonry Wall**

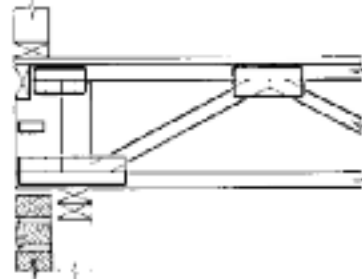

**Bottom Chord Bearing on Exterior Frame Wall with Masonry Fascia Wall**

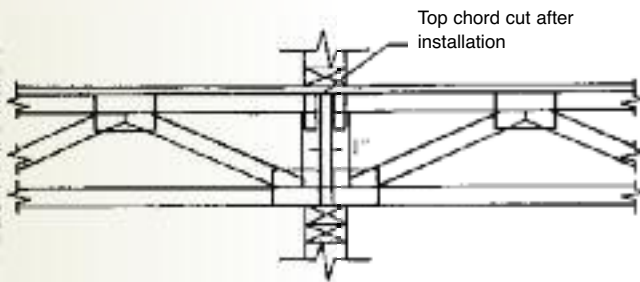

**Intermediate Bearing - Simple Span Trusses**

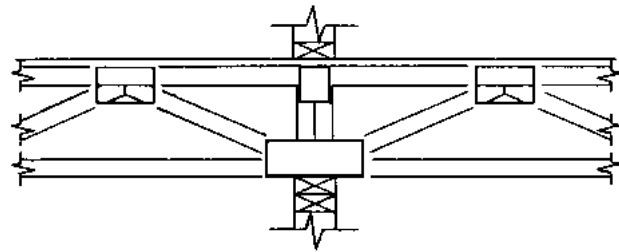

**Intermediate Bearing - Continuous Floor Truss**  
*Special Engineering Required*

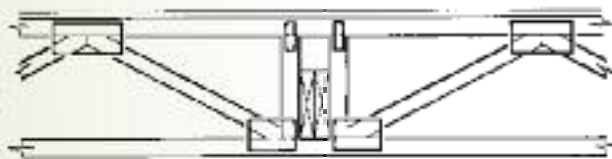

**Header Beam Pocket - Floor Truss Supporting Header Beam**  
*Special Engineering Required*

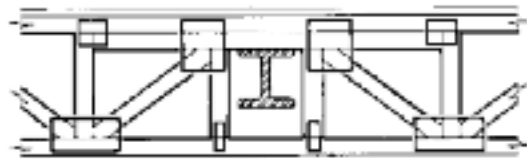

**Intermediate Bearing - Floor Truss Supported by Steel or Wood Beam**  
*Special Engineering Required*

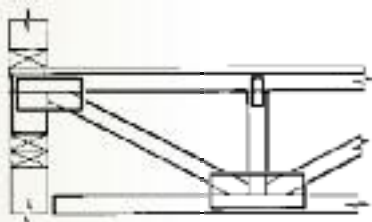

**Top Chord Bearing on Frame Wall**

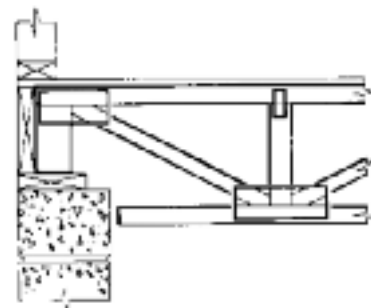

**Top Chord Bearing on Masonry Wall**

# Support Details

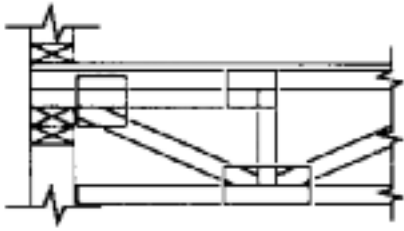

**Extended Top Chord Bearing**  
*Span Limited by Engineering*

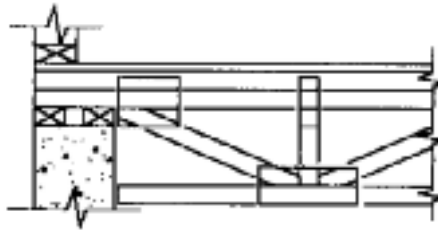

**Extended Top Chord Bearing**  
*Span Limited by Engineering*

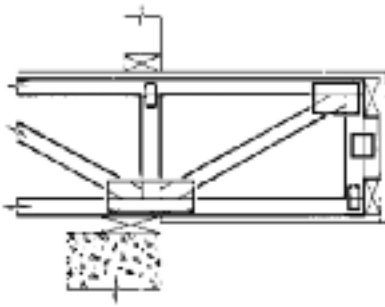

**Balcony Cantilever**  
*Special Engineering Required*

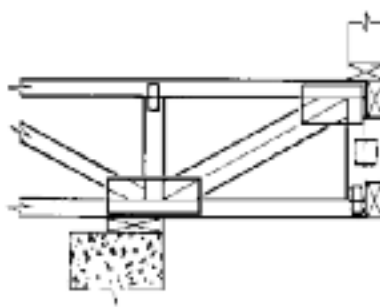

**Load-Bearing Wall Cantilever**  
*Special Engineering Required*

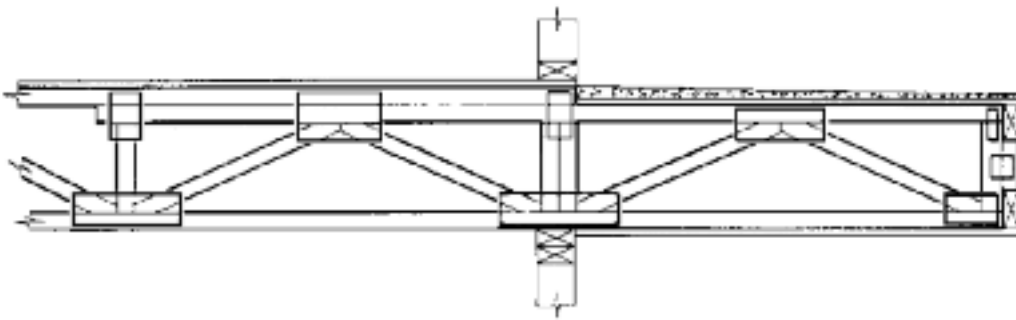

**Dropped Chord Balcony Cantilever**  
*Special Engineering Required*



# JOINT DETAILS

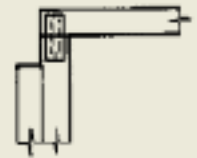
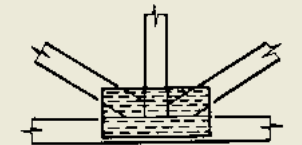
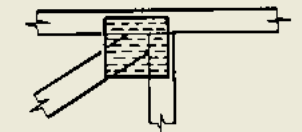

# JOINT DETAILS

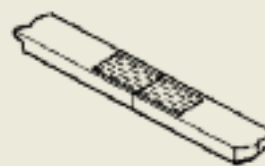
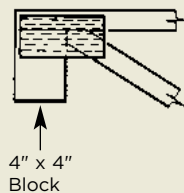
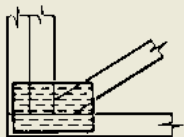

Chord Pre-Splice





# FLOOR TRUSS CONSTRUCTION DETAILS

## STRONGBACK SUPPORTS

### LATERAL BRACING SUGGESTIONS

2x6 "Strongback" lateral supports should be located on edge approximately every 10 feet along the floor truss.

They should be securely fastened to vertical webs. Blocking behind the vertical web is recommended while nailing the strongback. The strongbacks should either be secured to adjacent partition walls or alternate "X" bridging should be used to terminate the bracing member.

## Cantilever and Jack Details

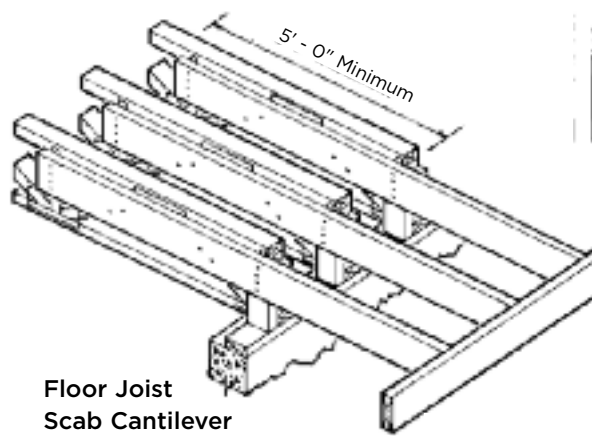

**Floor Joist Scab Cantilever**

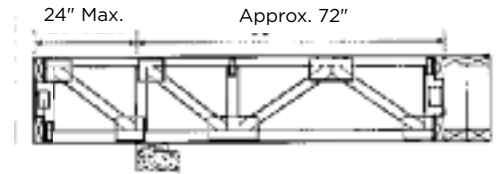

**Section AA - Floor Truss Jacks**

### Notes

- Special engineering required for girder floor trusses
- Slope for drainage, as required
- Cantilever span controlled by lumber size, grade and deflection limitations

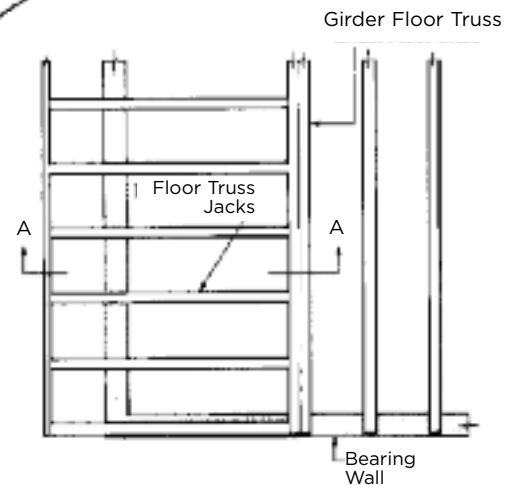

**Floor Cantilevered Perpendicular to Floor Truss Span**

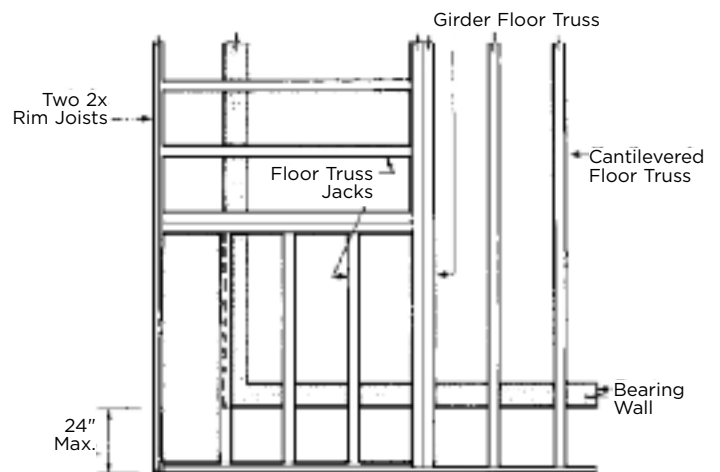

**Floor Cantilevered Perpendicular and Parallel to Floor Truss Span**

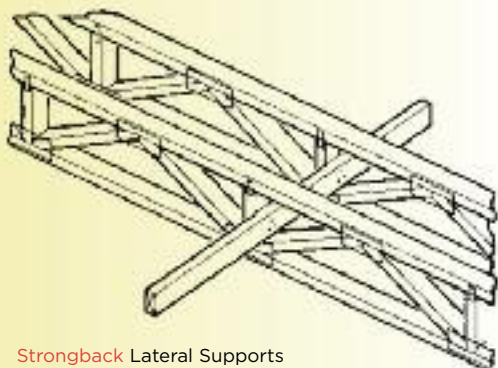

**Strongback Lateral Supports**

# Stairway and Stairwell Details



## STAIRWAY FRAMING

**Stairwell Opening without Stud Walls**

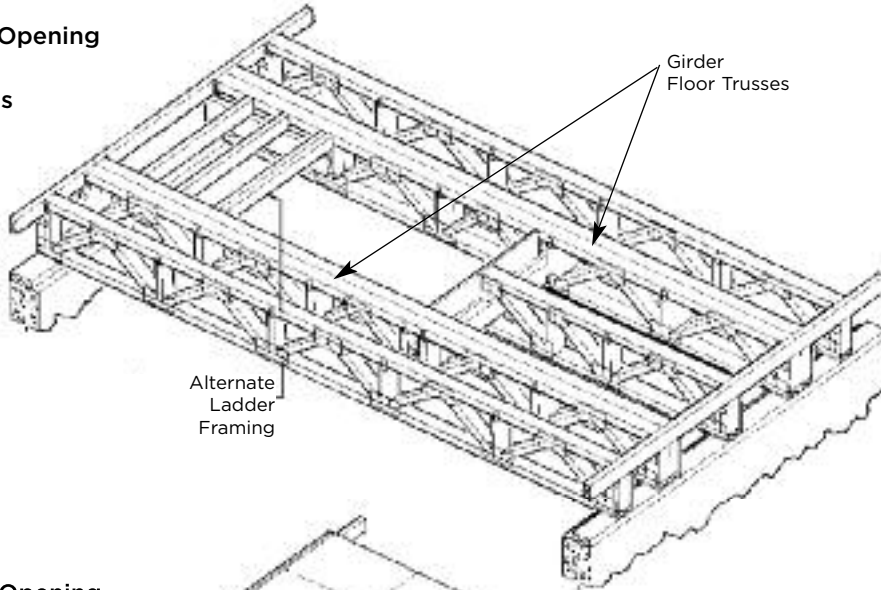

**Stairwell Opening Carried by Stud Wall**

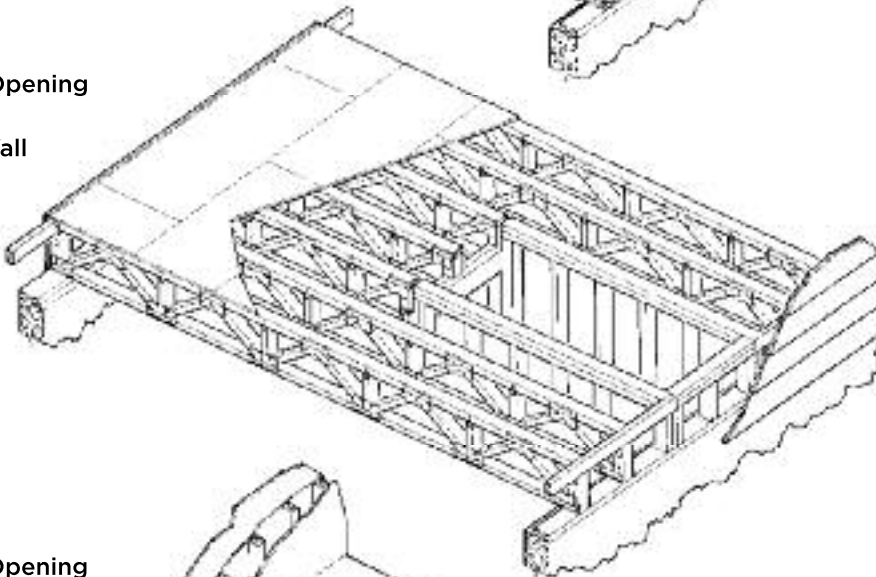

**Stairwell Opening Perpendicular to Floor Trusses, Carried by Stud Wall**

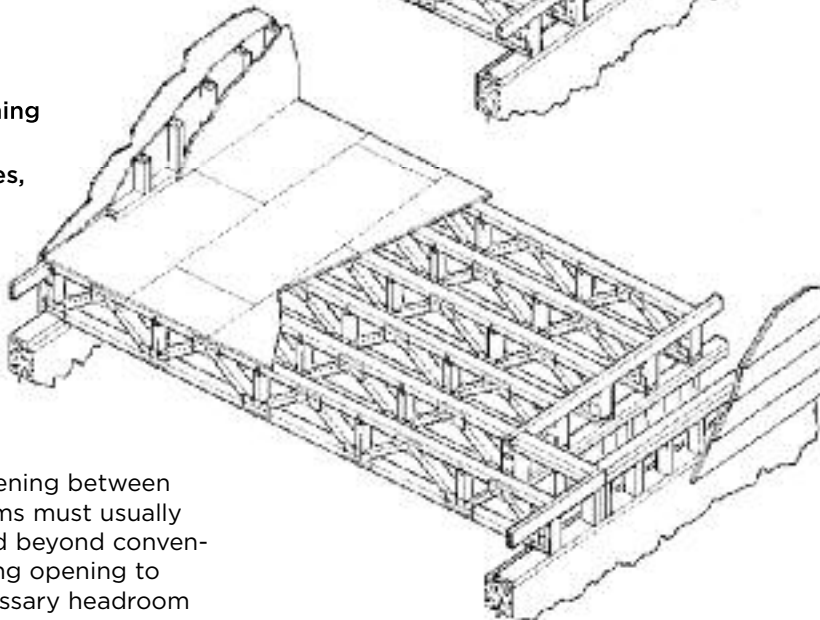

**Notes**

- Framing opening between header beams must usually be increased beyond conventional framing opening to permit necessary headroom
- Special engineering required for girder floor trusses

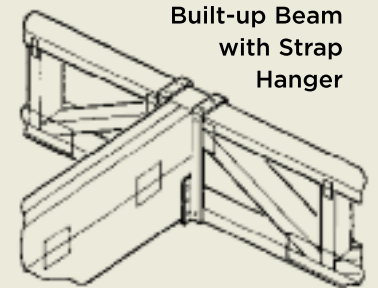

**Built-up Beam with Strap Hanger**

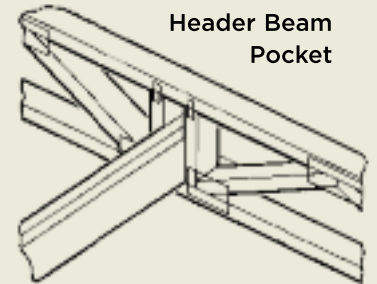

**Header Beam Pocket**

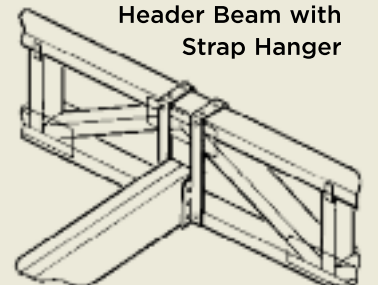

**Header Beam with Strap Hanger**

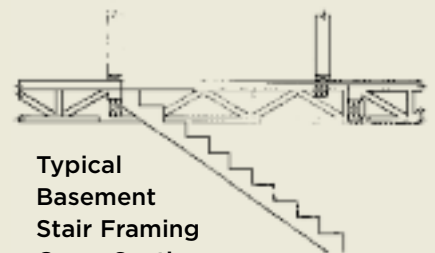

**Typical Basement Stair Framing Cross-Section**



# ARCHITECTURAL SPECIFICATION

## CONSTRUCTION GUIDELINES

### for ROOFS

- ✓ Support trusses that are stored horizontally on blocking to prevent excessive lateral bending and lessen moisture gain
- ✓ Brace trusses that are stored vertically, to prevent toppling or tipping
- ✓ Unload trusses on rough terrain or uneven surfaces, which could cause damage to the trusses
- ✓ Break banding until installation begins and the trusses are in a stable, horizontal position
- ✓ Lift bundled trusses by the bands and do not use damaged trusses
- ✓ Walk on trusses that are lying flat – this is a dangerous practice

- Trusses shall be fabricated by a MiTek truss manufacturer in accordance with MiTek floor truss engineering specifications
- MiTek engineering design drawings, bearing the seal of the registered engineer preparing the design, shall be provided to the project architect for his approval
- Truss designs shall be in accordance with the latest version of *ANSI/TPI1 National Design Standard for Metal Plates Connected Wood Truss Construction*, a publication of the Truss Plate Institute, and generally accepted engineering practice
- Delivery, handling, and erection of MiTek trusses shall be in accordance with the *BCSI, Building Component Safety Information*, jointly produced by SBCA and the Truss Plate Institute
- Anchorage, permanent bracing and required design loads shall be the responsibility of the building designer
- MiTek truss connector plates are manufactured under rigid quality control using structural quality steel meeting ANSI/TPI 1 requirements

### for FLOORS

- ✓ Color-code floor truss ends for correct non-symmetrical installations
- ✓ Locate trusses to allow for plumbing or duct riser clearances
- ✓ Assure that trusses are installed with a joint located over an interior bearing
- ✓ Use warning tags on floor trusses to provide proper installation orientation and to warn against cutting or modifying trusses
- ✓ Permit stacking of drywall or plywood sheathing during construction on floor truss balcony cantilevers or at truss mid-span without proper shoring
- ✓ Use floor trusses when exposed to weather, chemically corrosive environment or extremely high humidity
- ✓ Cut truss chords or webs or modify them in any way during construction

## RECOMMENDATIONS & LIMITATIONS FOR DEPTH, DEFLECTION AND CAMBER

In addition to allowable lumber stress limitations, floor truss designs are also regulated by maximum permissible deflection-to-span and depth-to-span limitations, as shown in the chart below. The suggested camber to be built into the truss during fabrication is also included.

The truss deflection is calculated by complex engineering methods which have been verified by extensive full-scale load tests. The floor span-to-depth limitation is intended to prevent objectionable floor vibration. All of the following recommended limitations should be achieved to provide a quality floor system and assure complete customer satisfaction.

	Floor	Roof
Minimum Depth	Span/20 inches	Span/24 inches
Maximum Deflection	Span/360 (Live Load)	Span/240 (Live Load)
Recommended Camber	Dead Load Deflection	Dead Load Deflection*

\* Provide a minimum slope of 1/4" per foot of span for proper drainage to prevent water ponding

For further information see the *BCSI, Building Component Safety Information Guide* jointly produced by SBCA and TPI.

# CONCENTRATED LOAD INFORMATION

## For Floor Trusses



## FLOOR TRUSS CANTILEVER CONCENTRATED LOADS

Concentrated Load at End of Cantilever (lbs.)			
Roof Span (Feet)	Roof Load (at 1.15) Plus Wall Load		
	20/10/0/10 = 40 psf	30/10/0/10 = 50 psf	40/10/0/10 = 60 psf
20	865	1040	1215
22	935	1125	1320
24	1005	1215	1425
26	1075	1300	1530
28	1145	1385	1630
30	1215	1475	1735
32	1285	1560	1840

Floor truss cantilevers often support load-bearing walls carrying roof live loads and wall material dead loads. The chart at left provides a convenient means of determining an equivalent concentrated load for representative roof loads which incorporate a 15% load duration factor for the roof load only.

## CONCENTRATED LOAD SAMPLE CALCULATION

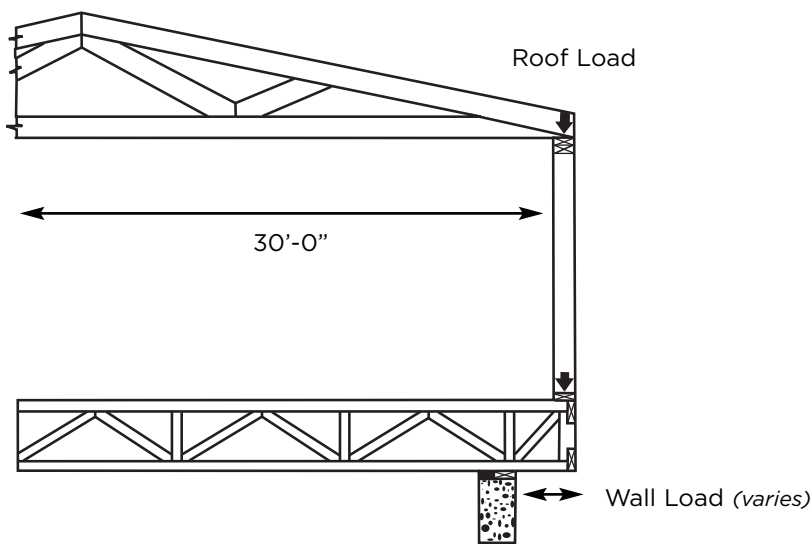

### Roof Loading =

$$20/10/0/10 = 40 \text{ psf @ 1.15}$$

$$\text{Roof Load (Roof Truss Reaction)} = 40 \text{ psf} \times (30'/2) \times 2'-0'' \text{ o.c.} = 1200 \text{ lbs.}$$

$$8' \text{ Stud Wall Weight (@ 85 lbs./lineal ft.)} = 85 \text{ plf} \times 2'-0'' \text{ o.c.} = 170 \text{ lbs.}$$

$$\text{Equivalent Floor Truss Load} = (1200/1.15) + 170 = 1215 \text{ lbs.}$$

Concentrated Load

### Note:

This is the concentrated load the floor truss should be designed for. Also check floor truss for dead load only at end of cantilever.



# TECHNICAL INFORMATION

## CODE APPROVALS

MiTek connector plates have been approved by all recognized national and regional model building code groups, based on extensive structural testing. The following approvals may be referenced for more detailed information.

### ✓ ICC-ES

ICC Evaluation Service, Inc.  
Reports: ESR-1311,  
ESR-1352, ESR-1988

### ✓ LA City

City of Los Angeles  
Research Report:  
RR25370

### ✓ Florida

Florida Department of  
Community Affairs  
FL #2197

## FLOOR DECKING INFORMATION

Virtually all decking systems may be easily applied to MiTek floor trusses. The wide 3-1/2" nailing surface assures that floor decks are installed accurately and quickly. The table below summarizes the plywood deck requirements presented by various American Plywood Association publications.

Floor Construction	Panel Indent	Thickness	Floor Truss Spacing
Conventional double-layer plywood underlayment over plywood sub-flooring	48/24	23/32", 3/4", 7/8"	24" Spacing
	40/20	19/32", 5/8", 3/4", 23/32"	19.2" Spacing
	32/16	15/32", 1/2", 5/8", 19/32"	16" Spacing
	24/16	7/16", 15/32", 1/2"	16" o.c. Spacing
APA Sturd-I-Floor (must be nailed or glued and nailed according to APA)	24	23/32", 3/4",	(Spacing equal to Panel Indent) Panels must either be tongue-and-groove or blocked between trusses
	20	19/32", 5/8"	
	16	19/32", 5/8"	
	32	7/8", 1"	
	48	1-1/8"	
APA Glued Floor System (must be glued according to APA Spec. AFG-01 and nailed)	24" Spacing	(Available thickness for either conventional subflooring plywood or for Sturd-I-Floor panels)	
	19.2" Spacing		
	16" Spacing		

Overall Truss Depth (Inches)	Width (W) (Inches)						Diameter (D) (Inches)
	When Height (H) Equals:						
	3"	4"	5"	6"	7"	8"	
12	32	25	19	12	6	-	7
13	34	28	23	17	11	5	8
14	36	31	26	20	15	10	9
15	38	33	28	23	19	14	10
16	40	35	31	26	22	17	11
17	41	37	32	28	24	20	12
18	42	38	34	30	26	22	13
19	43	39	36	32	28	25	14
20	44	40	37	33	30	26	15
21	44	41	38	35	31	28	16
22	45	42	39	36	33	30	17
23	46	43	40	37	34	31	18
24	46	43	41	38	35	32	18-1/2

## MAXIMUM MECHANICAL SERVICE CLEARANCES

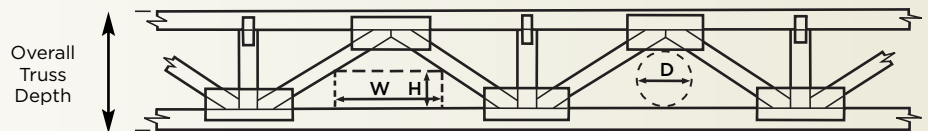



# ONE-HOUR FIRE RATING

## For Floor Trusses



### FIRE TESTS

#### Design No. MCI/FCA 60-02 with Floor Truss Assembly Rating: 60 minutes - Unrestrained Floor/Ceiling Assembly; Finish Rating: 22 minutes

1. Topping (Optional): Subject to design and project limitations, these systems may be augmented with a lightweight floor topping mix containing perlite or vermiculite aggregate.
2. Flooring: Minimum 5/8" (15.9mm) plywood or O-2 grade waferboard or strandboard. See General Information for spacing > 16" (400mm) oc. 19.2" (500mm) is 3/4" (19.0mm) oc. 24" (600mm) is 3/4" (19.0mm) oc
3. Structural Members: MiTek Canada Inc. Metal Truss Plates with structural graded chords and webs as per NLGA grading rules. All Floor Trusses are to be designed and sealed by a Professional Engineer.
4. Furring Channels (Resilient Channel): 7/8" deep with 26 gauge galvanized steel wired to underside of each truss with double strands of 18 gauge steel tie wire or screwed to each truss with 1-1/4" Type S drywall screws. Double rows of furring channels at each gypsum wallboard joist (at least 3" apart).
5. Bridging/Strongback: 2 x 6 SPF #2 to be screwed to the bottom chord with two 3" screws and spaced 7' oc.
6. Gypsum Board: 4' x 10' x 5/8" Type C (listed Firecode C or Westroc Fireboard C) with edges running perpendicular to the furring channels. Screwed to channels with 1-1/4" Type S bugle head drywall screws set at 12" oc & 1-1/2" from edges of board (minimum). All joints to be taped. Joints and screw heads covered with 2 layers of gyproc joint filler.
7. Insulation (optional): It may be 3-1/2" (89mm) thick fiberglass insulation batts with density 0.75 lb/cu. ft. All batts are to be placed between bottom joist flanges and supported by metal furring channels. All butt joints shall be over furring channels.

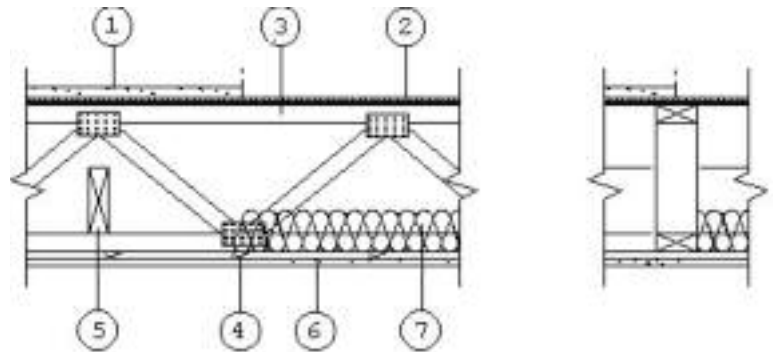

**SEE NEXT PAGE  
FOR GENERAL  
INFORMATION**

#### GA\* Design No. FC 5517

3/4" T&G plywood, glued and nailed with alt. lightweight concrete

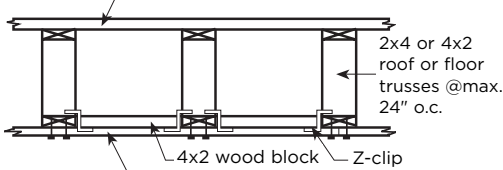

1 layer 5/8" thick USG Firecode C, Type C gypsum wallboard fastened with 1-7/8" Type S screws @ 8" o.c.

#### UL\*\* Design No. L528

3/4" T&G plywood, glued and nailed with alt. lightweight concrete

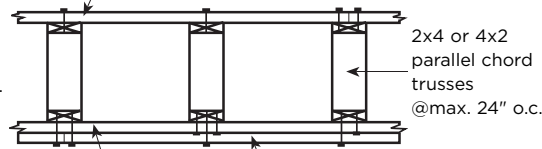

Furring channels 1 layer 5/8" thick Type C, USG gypsum wallboard secured with screws, joints finished

#### UL\*\* Design No. L529

3/4" T&G plywood, glued and nailed with alt. lightweight concrete

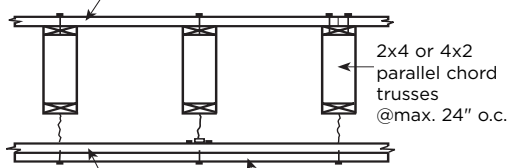

Steel cross tees and runners 1 layer 5/8" thick Type C, USG gypsum wallboard secured with screws, joints finished

#### Factory Mutual\*\*\* Design FC214

3/4" T&G plywood, glued and nailed

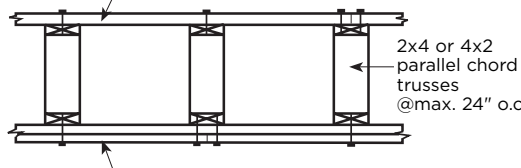

2 layers 1/2" thick Type FSW-1, NGC gypsum wallboard, secured with screws, joints finished

Sample illustrations of fire rating test assemblies appear at left. Copies of these and other reports may be obtained from the listing agency.

Additional information on fire-rated assemblies for MiTek products can be obtained from MiTek's engineering department. For general information on fire rated assemblies (and the effects of fire on wood trusses), visit the SBCA (Structural Building Components Association) website. The *Truss Technology in Building* document "Fire Resistance Rated Truss Assemblies" covers a variety of assemblies.



\* Gypsum Association 810 First Street NE, #10 Washington, DC 20002  
 \*\* Underwriters Laboratory, Inc. 333 Pfingsten Road Northbrook, IL 60062  
 \*\*\* Factory Mutual Research 1151 Boston-Providence Road Norwood, MA 02062



# MITEK FIRE DESIGN LISTING

## GENERAL INFORMATION

*continued from page 15*

### Roof/Ceiling, Floor Ceiling, Beam & Column Assemblies

MiTek Canada Inc. fire design listings are based on, and supported by, proprietary test reports which have been reviewed and evaluated by Intertek. The test reports further define proprietary design details which make these listings applicable only to the specified products manufactured by MiTek Canada Inc.

The following fire assembly designs are listed in accordance with ASTM-E119 (Fire Tests of Building Construction Materials), CAN/ULC-S101 (Standard Methods of Fire Endurance Tests of Building Construction and Materials), NFPA-251 (Fires Tests of Building Construction and Materials), UBC-7-1 (*formerly UBC-43-1*), Uniform Building Code Standard).

### General Information Applicable to all MiTek Designs

**Floor Topping:** Subject to design and project limitations, these systems may be augmented with a lightweight floor topping mix containing perlite or vermiculite aggregate.

**Sub-Flooring:** Sub-floor panels to conform to one of the following:

Material	Canadian Std.	U.S. Std.
Douglas Fir Plywood	CAN/CSA-0121	PS-1-83 Grp 1 strut.
Softwood Plywood	CAN/CSA-0151	PS-1-83 Grp III C-D
Poplar Plywood	CAN/CSA-0153	PS-1-83 C-D
Waferboard and Strandboard	CAN-0437.0	
Sheathing	CAN/CSA-0325.0	PS-2-92

Note: All plywood are to be produced with adhesive qualified as interior use/ exterior grade (exposure 1) or better.

Unless otherwise noted, panels are T & G, maximum width 48" with long dimensions installed perpendicular to joists. End joists are staggered minimum 24" and butted over joists. Unless otherwise noted, minimum nominal thickness of sub-flooring is:

Maximum Joists Spacing (mm)	Plywood & O-2 Grade Waferboard & Strandboard (mm)	Waferboard & Strandboard R-1 & O-1 Grade (mm)
16" (400)	5/8" (15.9)	5/8" (15.9)
19.2" (500)	3/4" (19.0)	3/4" (19.0)
24" (600)	3/4" (19.0)	3/4" (19.0)

**Sub-Flooring Fastening:** Minimum length of fastener for sheathing and subfloor attachment for thickness from 5/8" (15.9mm) to 3/4" (19.0mm) thick is:

- Common or Spiral Nail: 2" (51mm) (Canada); 8d (0.131" dia. x 2.5" long) (U.S.)
- Ring Thread Nail: 1-3/4" (45mm) (Canada); 6d (0.120" dia. x 2" long) (U.S.)

Nail spacing shall be 6" (150mm) o.c. along butt edges of panel and 12" (300mm) (Canada) and 10" (U.S.) o.c. along intermediate support.

**Structural Members:** Listed fire designs are based on systems designed for structural and functional performance in accordance with MiTek Canada Inc. procedures. All designs are tested in unrestrained configuration. The chord materials are structural rated lumber material as graded under NLGA-1993 Standard Grading rules for Canadian Lumber or graded by an inspection bureau or agency approved by the U.S. Department of Commerce Board of Review of the American Lumber Standards Committee with chord sizes of 3x2, 4x2, 5x2.

MiTek Posi-Strut Series: Unless otherwise specified, this includes PS-10, PS-10V2, PS-12, PS12V2, PS-12i, PS-13, PS-14, PS-14V3, PS-16, PS-16V3 metal webs having a minimum depth of 9-1/4" and spaced up to a maximum of 24" o.c. for floor/ceiling systems. MiTek Floor Truss Series: Unless otherwise specified, this includes wood web floor truss designs with metal truss plates manufactured by MiTek Canada Inc. having a minimum depth of 10" and spaced up to a maximum of 24" o.c. for floor/ceiling systems.

**Resilient Channel:** Can be used in all cases, directly applied to joists. Minimum requirement is 26 gauge galvanized steel. Unless otherwise noted, maximum spacing is 24" o.c., perpendicular to joists and fastened to each joist with one 1-1/4" Type S drywall screw. Double rows of furring channels at each gypsum wall board joint (at least 3" apart).

**Gypsum Board:** All Gypsum Board is listed 5/8" (15.9mm) Type X, unless otherwise noted. In certain cases, as noted, it may be specific proprietary type with other designations identified in conjunction with the manufacturer's name. Maximum width is 48" and unless otherwise noted, all exposed joints are taped and finished with two additional coats of joint compound. Screw heads are covered with two coats of joint compound.

**Bridging/Strongback:** 2x6 Bridging/Strongback to be attached to each bottom chord of the assembly with two 3" screws and to be spaced 7" o.c.

**Insulation:** Where design requires insulation, it shall be 1-1/2" (38mm) thick mineral wool insulation batts. Where insulation is optional, it may be 3-1/2" (89mm) thick fiberglass insulation batts with density 0.75 lb/cu. ft. All batts are to be placed between bottom joist flanges and supported by metal furring channels. All butt joints shall be over furring channels.

**Suspended Ceiling System:** Any suspended ceiling system may be selected which satisfies the following criteria:

- It must be a fire-rated system, and be installed within the terms of its listing.
- It must have a finish rating equal to or greater than the finish rating required by the suspended ceiling design.
- It must be suspended in accordance with the terms of its listing and a minimum of 7-1/2" below the joist.
- Penetrations such as ducts, air diffusers, and fixtures must be protected in such a manner as to conform to the terms of the listing of the suspended ceiling system.

# SOUND TRANSMISSION RATINGS

## Technical Information - Floor/Ceiling Systems

Various floor-ceiling systems exhibit different abilities to reduce sound transfer from one room to another. This sound transmission resistance is measured by two indices - the Sound Transmission Class (STC) which rates airborne sounds to evaluate the comfortability of a particular living space and the Impact Insulation Class (IIC) which rates the impact sound transmission performance of an assembly. These ratings are used by regional building codes to regulate permissible sound transfer.

For more detailed information reference the *Metal Plate Connected Wood Truss Handbook*, ©1993 Wood Truss Council of America, Section 18.0 - Transitory Floor Vibration and Sound Transmission. (WTCA is now known as SBCA, Structural Building Components Association).

Description	STC High Frequency	IIC Low Frequency
<b>Basic Wood Floor</b> - consisting of wood joist (1-joist, solid-sawn or truss), 3/4" decking and 5/8" gypsum wallboard attached directly to ceiling	36	33
<b>Cushioned Vinyl or Linoleum</b>	0	2
<b>Non-cushioned Vinyl or Linoleum</b>	0	0
<b>1/2" Parquet Flooring</b>	0	1
<b>3/4" Gypcrete® or Elastizel®</b>	7-8	1
<b>1-1/2" Lightweight Concrete</b>	7-8	1
<b>1/2" Sound Deadening Board (USG)*</b>	1	5
<b>Quiet-Cor® Underlayment by Tarkett, Inc*</b>	1	8
<b>Enkasonic® by American Enka Company*</b>	4	13
<b>Sempafloor® by Laminating Services, Inc.*</b>	1	11
<b>R-19 Batt Insulation</b>	2	0
<b>R-11 Batt Insulation</b>	1	0
<b>3" Mineral Wood Insulation</b>	1	0
<b>Resilient Channel</b>	10	8
<b>Resilient with Insulation</b>	13	15
<b>Extra Layer of 5/8" Gypsum Wallboard</b>	0-2	2-4
<b>Carpet and Padding</b>	0	20-25

\* Estimates base on proprietary literature. Verify with individual companies. The information in the chart above was excerpted from the *Construction Guide for Southern Pine Joist & Rafters*. Southern Pine Council, 1993.



### CALCULATION EXAMPLE

Description	STC	IIC
Carpet and Padding	0	20
3/4" Gypcrete	7	1
Wood Truss Floor	36	33
Resilient Channel	10	8
<b>Total</b>	<b>53</b>	<b>62</b>

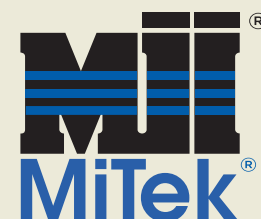

# TECHNICAL INFORMATION

## APPLIED LOADS

### REPRESENTATIVE FLOOR & ROOF LOADING

#### Residential Flooring

**40 psf TC live load**

**10 psf TC dead load**

(3/4" plywood decking)

**0 psf BC live load**

**5 psf BC dead load**

(1/2" to 5/8" drywall)

**55 psf total load**

(If heavy insulation or 2-ply drywall ceiling, BC dead load = 10 psf and 40/10/0/10 = 60 psf total load)

#### Commercial

(Also Multi-Family Dwellings)

**40 psf TC live load**

(heavier depending on use)

**25 psf TC dead load**

(1-1/2" to 2" thick lightweight concrete cap)

**0 psf BC live load**

**10 psf BC dead load**

**75 psf total load**

#### Residential, Commercial Roofing

**20, 25, 30, 40, 50 psf TC live load**

(dependent on local building code requirements)

**10 psf TC dead load**

(heavier for tile)

**0 psf BC live load**

**10 psf BC dead load**

**40 to 70 psf total load**

(dependent on TC live load)

#### Notes

- Above representative loads are typical loading requirements for many regions in the country. However, the required applied loading for design purposes is the responsibility of the building designer, within the limitations of the prevailing local, state or regional building code specifications.
- Roof trusses to be checked for local wind loadings.
- Commercial floors may require additional load cases.

## TYPICAL CONSTRUCTION MATERIAL WEIGHTS

<b>Floors</b>	<b>psf</b>	<b>Composition Roofing</b>	<b>psf</b>
Hardwood (1 in. thick) .....	3.8	235 lb. shingles and paper .....	2.5
Concrete		2-15 lb. and 1-90 lb. ....	1.7
Regular (1 in. thick) .....	12.0	3-15 lb. and 1-90 lb. ....	2.2
Lightweight (1 in. thick) .....	8.0	3-ply and gravel .....	5.6
Linoleum .....	1.5	4-ply and gravel .....	6.0
3/4" ceramic or quarry tile .....	10.0		
<b>Ceilings</b>	<b>psf</b>	<b>Roof and Floor Sheathing And Decking</b>	<b>psf</b>
Acoustical fiber tile .....	1.0	1/2 in. plywood .....	1.5
1/2 in. gypsum board .....	2.0	5/8 in. plywood .....	1.8
5/8 in. gypsum board .....	2.5	3/4 in. plywood .....	2.3
Plaster (1 in. thick) .....	8.0	1-1/8 in. plywood .....	3.4
Metal suspension system .....	0.5	1 in. sheathing (nominal) .....	2.3
Wood suspension system .....	2.0	2 in. decking .....	4.3
		Tectum (1 in. thick) .....	2.0
<b>Miscellaneous</b>	<b>psf</b>	Poured gypsum (1 in. thick) .....	6.5
Sprinkling system .....	1.0 to 1.5	Vermiculite concrete (1 in. thick) .....	2.7
Ductwork (24g) .....	3.0 to 5.0		
Rigid fiberglass (1 in. thick) .....	1.5	<b>Partition Wall Weights (approx.) plf</b>	<b>(approx.) plf</b>
Roll or batt insulation (1 in.) .....	0.3	<b>(8' Nominal Height)</b>	
Glass or rock wool (1 in. thick) .....	0.3	Interior partition (studs @ 16" o.c.) ...	.50
		Exterior partition (studs @ 16" o.c. and composition exterior) .....	.85
<b>Floor Truss Weights (approx.) plf or psf</b>		Exterior partition - (studs @ 16" o.c. and brick exterior) .....	.180
Single chord .....	5.5 plf		
@ 24" o.c. spacing .....	2.75 psf		
Double chord .....	8.5 plf		
@ 24" o.c. spacing .....	4.25 psf		

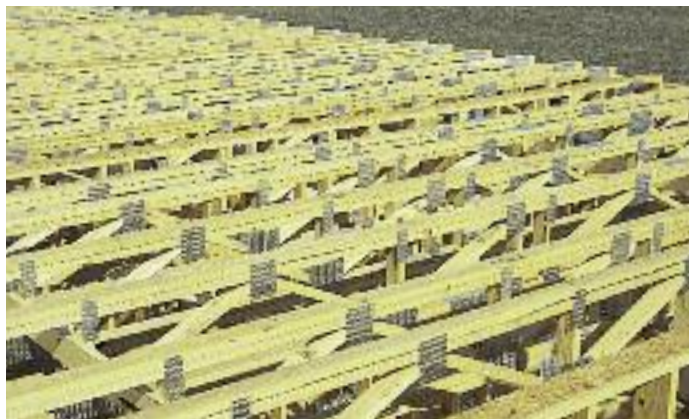

# MITEK<sup>®</sup> FLOOR TRUSS MAX-SPANS



**Note: The following max-spans are valid for lumber design only. Plating or other considerations may further limit the truss design.**

The chord max-spans shown below, presented for six representative floor loadings, are intended for use in bidding, estimating, and preliminary design applications. For proper interpretation of these max-spans, note:

- The max-spans are valid for the following (or better) lumber: 4x2 Southern Pine MSR 1850f 1.7E. Shorter spans will be achieved using lesser grade 4x2 lumber, while longer spans are generally possible with higher grade lumber.
- The max-spans represent truss overall lengths, assuming 3-1/2" bearing at each end. The spans are equally valid for top chord-bearing and bottom chord bearing support conditions.

- The minimum truss span-to-live load deflection is 360 for floor application. For example, the maximum permissible live load deflection for a 20' span floor truss is  $(20 \times 12)/360 = 0.67"$ .
- In addition to the consideration of lumber strength and deflection limitations, the maximum truss span-to-depth ratio is limited to 20 for floor loadings.  
For example the maximum span of a floor application truss 15" deep is  $15" \times 20' = 300"$  span = 25' - 0" span.
- Floor loadings have included 1.00 Load Duration Increase and 1.15 Repetitive Stress Increase.

## 40/10/0/5 = 55 PSF @ 0%

Depth (inches)	24" o.c.	19.2" o.c.	16" o.c.	12" o.c.
12	17-11	20-03	20-06	20-06
13	18-09	21-02	22-02	22-02
14	19-17	22-01	23-11	23-11
15	20-04	22-11	25-03	25-07
16	21-01	23-09	26-02	27-04
17	21-09	24-07	27-01	29-00
18	22-06	25-04	27-11	30-09
20	23-10	26-10	29-07	34-02
22	25-01	28-03	31-02	36-03
24	26-03	29-07	32-07	37-11

## 40/10/0/10 = 60 PSF @ 0%

Depth (inches)	24" o.c.	19.2" o.c.	16" o.c.	12" o.c.
12	16-04	18-08	20-06	20-06
13	17-02	19-06	21-08	22-02
14	17-11	20-04	22-07	23-11
15	18-07	21-02	23-06	25-07
16	19-03	21-11	24-04	27-03
17	19-11	22-08	25-02	29-00
18	20-06	23-05	25-11	30-05
20	21-09	24-09	27-06	32-03
22	22-11	26-01	28-11	33-11
24	24-00	27-04	30-04	35-06

## 50/10/0/10 = 70 PSF @ 0%

Depth (inches)	24" o.c.	19.2" o.c.	16" o.c.	12" o.c.
12	15-02	17-03	19-02	20-06
13	15-10	18-01	20-00	22-02
14	16-06	18-10	20-11	23-11
15	17-02	19-07	21-09	25-06
16	17-10	20-04	22-06	26-05
17	18-05	21-00	23-03	27-04
18	19-00	21-08	24-00	28-02
20	20-02	22-11	25-05	29-10
22	21-02	24-02	26-09	31-05
24	22-02	25-04	28-01	32-11

## 40/25/0/10 = 75 PSF @ 0%

Depth (inches)	24" o.c.	19.2" o.c.	16" o.c.	12" o.c.
12	14-08	16-08	18-06	20-06
13	15-04	17-06	19-04	22-02
14	16-00	18-02	20-02	23-08
15	16-07	18-11	21-00	24-07
16	17-02	19-07	21-09	25-06
17	17-09	20-03	22-06	26-04
18	18-04	20-11	23-03	27-03
20	19-05	22-02	24-07	28-10
22	20-06	23-04	25-11	30-04
24	21-05	24-05	27-01	31-09

## 50/20/0/10 = 85 PSF @ 0%

Depth (inches)	24" o.c.	19.2" o.c.	16" o.c.	12" o.c.
12	13-09	15-08	17-05	20-05
13	14-05	16-05	18-02	21-04
14	15-00	17-01	19-00	22-03
15	15-07	17-09	19-09	23-02
16	16-02	18-05	20-05	23-11
17	16-08	19-00	21-02	24-09
18	17-03	19-08	21-10	25-07
20	18-03	20-10	23-01	27-01
22	19-03	21-11	24-04	28-06
24	20-02	22-11	25-06	29-10

## 50/35/0/10 = 95 @ 0%

Depth (inches)	24" o.c.	19.2" o.c.	16" o.c.	12" o.c.
12	13-00	14-10	16-05	19-03
13	13-07	15-06	17-02	20-02
14	14-02	16-02	17-11	21-00
15	14-09	16-10	18-08	21-11
16	15-03	17-05	19-04	22-08
17	15-10	18-00	20-00	23-05
18	16-04	18-07	20-07	24-02
20	17-03	19-08	21-10	25-07
22	18-02	20-09	23-00	26-11
24	19-00	21-09	24-01	28-03



# GLOSSARY OF TERMS

**4x2 Member** A 2x4 lumber section used as a structural component oriented such that its 3-1/2" (4" nominal) face is horizontal.

**Apex/Peak** The uppermost point of a truss.

**Axial Force** A push (compression) or pull (tension) acting along the length of a member. Usually measured in pounds or kips (1,000 lbs.) or metric equivalent.

**Axial Stress** The axial force acting at a point along the length of a member divided by the cross-sectional area of the member. Usually measured in pounds per square inch.

**Balcony Cantilever** A floor truss cantilever serving only as a balcony with no additional wall loading acting on the cantilever portion.

**Beam Pocket** A rectangular opening within a truss to accept a header beam for positive load transfer.

**Bearing** A structural support, usually a wall, that occurs at the top or bottom chord or between the end points of a roof or floor truss.

**Bending Moment** A measure of the bending effect on a member due to forces acting perpendicular to the length of the member.

**Bending Stress** The force per square inch of area acting at a point along the length of a member, resulting from the bending moment applied at that point. Usually measured in pounds per square inch or metric equivalent.

**Bottom Chord** The continuous 4x2 member forming the bottom of the truss.

**Bottom Chord Bearing** A floor truss support condition in which the truss load is transferred to the bearing or support through the bottom chord "sitting" on the support.

**Butt Cut** Slight vertical cut at the outside edge of truss bottom chord made to ensure uniform span and tight joints - usually 1/4 inch.

**Camber** An upward curvature built into a truss during fabrication to counteract downward deflection of the loaded truss.

**Cantilever** The portion of a truss extending beyond the exterior face of a support (excluding the overhang).

**Chase** The opening in some floor trusses or structural components in which the mechanical equipment (ducts, plumbing, etc.) runs, typically a rectangular opening at the centerline. (Also referred to as a Duct Opening.)

**Check** A lengthwise separation of wood fibers, usually extending across the rings of annual growth, caused chiefly by strains produced in seasoning.

**Chord Splice** A connection of the 4x2 chord member between joints, joined by pre-splice connector plates into the 3-1/2" faces and occasionally side plates into the 1-1/2" edges.

**Clear Span** Horizontal distance between interior edges of supports.

**Combined Stress** The combination of axial and bending stresses acting on a member simultaneously, such as occurs in the top chord (compression + bending) or bottom chord (tension + bending) of a truss.

**Combined Stress Index (CSI)** The summation of axial and bending stresses divided by their respective allowable stresses for a specific truss member. This ratio, or index, represents the structural "efficiency" of the member. The CSI shall not exceed 1.00.

**Concentrated Load** Loading applied at a specific point, such as a load-bearing wall running perpendicular to a truss, or a roof-mounted A/C unit hanging from a truss.

**Connector Plate** Pre-punched metal toothed connectors located at the joints and splices of a truss and designed to transfer the forces which occur at those locations.

**Continuous Lateral Restraint (Brace)** A member placed and connected at right angles to a chord or web member of a truss to prevent out of plane buckling.

**Cripple Rafter** Infill rafter installed to continue the roof line - fixed to valley board in valley construction.

**Dead Load** Any permanent load such as the weight of roofing, flooring, sheathing, insulation or ceiling material, as well as the weight of the truss itself.

**Design Loads** The dead and live loads which a truss is engineered to support.

**Deflection** The maximum vertical displacement of a structural member due to applied loading. (Live load deflection is the displacement due to live load.)

**Depth** The overall distance from the top of the top chord to the bottom of the bottom chord.

**Dimensional Take-Up** The adjustment necessary to alter standard repetitive floor truss panel lengths to achieve the desired overall truss span. Take-up can be made at one end, both ends, or in the center.

**Doubled Chords** The use of two 4x2 members along specified top or bottom chord panels to achieve added strength.

**Dropped Cantilever** The use of overlapping 4x2 floor truss top chord members to frame a balcony cantilever with a "step-down" of 1-1/2" or 3" to provide positive drainage or application of concrete deck.

**Duration of Load (DDL) Increase** A percentage increase in the stress permitted in a member, based on the length of time that the load causing the stress acts on the member. The shorter the duration of the load, the higher the percent increase in allowable stress.

**End Detail** The end detail provides the support condition and necessary web orientation and panel length to create the desired truss span.

**Engineer Sealed Drawing** A truss design where loading requirements, lumber species, sizes, grades and connector plate requirements are detailed and a certified engineer's seal is affixed.

**Extended Top Chord Bearing** A floor truss support condition in which the truss load is transferred to the support through the top chord member extending to "sit" on the support.

**Fan Truss** A floor truss with 30" top chord panels and 60" bottom chord panels and a fan web configuration.

**Forces** Axial compression or tension in structural components due to applied loads.

**Girder** A structural member carrying large loads due to attachment of trusses framing into the girder (commonly called tie-in trusses).

**Girder Truss** Usually a multiple-ply truss designed to carry other trusses over an opening.

**Header Beam** A short beam typically supporting framing adjacent to a stair opening, running perpendicular to the floor trusses.

**Header Truss** A truss with 4x2 chords typically supporting roof, wall and/or upper floor loads, spanning over door or window openings. (For example, a garage door header truss.)

**Heel** Point on a truss at which the top and bottom chords intersect.

**Heel Cut** See Butt Cut.

**Heel Height** Vertical overall measurements at the end of a truss where the top and bottom chords meet.

**Interior Bearing** Any intermediate support condition in addition to the two exterior supports. A truss joint must be located above an interior bearing.

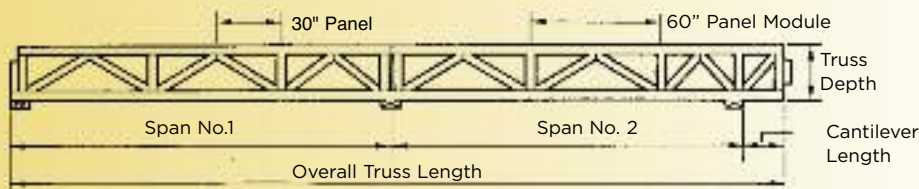

# TYPICAL FLOOR TRUSS

**Jack Rafter** Infill rafter installed to continue the roof line - fixed from wall plate to hip board in hip end construction.

**Joint** The intersection of two or more members. (Also referred to as a Panel Point.)

**Joint Splice** A splice of a chord member at a chord-and-web joint.

**Kneewall** A short partition stud wall to increase a wall height, typically from the concrete wall plate to the floor decking.

**Level Return** A lumber filler placed horizontally from the end of an overhang to the outside wall to form a soffit.

**L/D Ratio** The ratio of the truss span (L) to its depth (D), both dimensions in inches.

**Live Load** Any temporary applied load to a floor truss chord; typically roof live load is snow, while floor live loads are furniture, human occupancy, storage.

**Load-Bearing Wall** A wall specifically designed to transfer a roof load and/or upper floor load into the foundation.

**Machine Stress Rated Lumber (MSR)** Lumber which has been individually tested by a machine at the lumber mill to determine its structural design properties. MSR Lumber is designated by a flexural (bending) stress and Modulus of Elasticity, e.g., 1650F-1.5E.

**Moisture Content of Wood** The amount of moisture in wood expressed as a percentage of its oven-dry weight.

**Moments** A structural measure of the effects of bending on a member due to applied loading.

**Overall Rise** Vertical distance from bottommost part of the bottom chord to uppermost point on the top chord.

**Overhang** The extension of the top chord of a truss beyond the heel measured horizontally.

**PCT** Abbreviation for Parallel Chord Truss.

**PLF** Pounds per lineal foot, acting along a structural member, usually equal to the uniform load (PSF) times the truss spacing.

**PSF** Pounds per square foot of uniform load.

**Panel Length** The distance between the centerlines of two consecutive joints along the top or bottom chord.

**Panel** The chord segment defined by two adjacent joints.

**Panel Point** The point where a web or webs intersect a chord.

**Peak** Point on truss where the sloped top chords meet.

**Pitch** Inches of vertical rise for each 12 inches of horizontal run.

**Plate** A horizontal wood framing member, typically the top and bottom 2x4 members of a stud wall or the 2x6 sill plate bolted to a concrete wall for floor structural attachment. This provides the truss bearing.

**Plenum** Typically, the use of the entire floor truss cavity formed by the floor above and the ceiling below as a supply or return air "duct".

**Plumb Cut** Top chord end cut to provide for vertical (plumb) installation to fascia (face trim board).

**Pre-Splice Plates** Connector Plates pressed into the top and bottom 3-1/2" faces of two 4x2 chord members prior to final floor truss assembly to achieve a structural chord splice.

**Purlins** Lumber (secondary structural components) spanning between trusses to support roof covering (sheathing).

**1/4 Point** point on triangular, Fink or Howe truss where the webs connect to the top chord.

**1/3 Point** Point on triangular, Fink truss where the webs connect to the bottom chord.

**Reaction** The total load transferred from the uniform load (PSF) applied to the truss deck, then into the truss, and ultimately, to the truss bearing or support.

**Ridge** Line formed by truss peaks.

**Rim Joist** An exterior transition member supporting the decking edge and wall sheathing, usually tying the ends of floor trusses together. (Also referred to as a Ribbon or Band Board.)

**Scab** Additional timber connected to the face of a truss member to effect a splice, extension or general reinforcement.

**Shop Drawing** Provides detailed information for cutting of individual truss members.

**Slope** See Pitch.

**Spacing** The centerline-to-centerline distance between trusses.

**Span** The overall distance between adjacent interior supports or to the outside of supports when at the end of a truss. (See detail above.)

**Splice Point** (Top & Bottom chord splice). The point at which two chord members are joined together to form a single member. It may occur at a panel point or between panel points.

**Square Cut** End of top chord cut perpendicular to slope of the member.

**Strongback** A 2x6 lateral brace, used in a vertical orientation, running perpendicular to the trusses, and attached to the truss vertical web members.

**Support** The structural element resisting the truss, usually a wall or beam. (Also referred to as a Bearing.)

**Symmetrical Truss** Truss with the same configuration of members and design loading occurring on each side of truss centerline.

**Top Chord** The 4x2 member forming the top of the truss.

**Top Chord Bearing** A floor truss support condition in which the truss load is transferred to the bearing or support through the top chord or a 4x4 block end detail. With a 4x4 block, this is referred to as an intermediate height bearing.

**Truss** A pre-built component that functions as a structural support member. A truss employs one or more triangles in its construction.

**Truss-clip** Metal component designed to provide structural connection of trusses to wall plates to resist wind uplift forces.

**Visual Grade Lumber** Lumber which has been visually rated at the lumber mill for structural properties through rules established by national lumber species associations.

**Warren Truss** A general truss configuration with repetitive web "W" orientation. For floor truss applications, the top and bottom chord panels are typically 30" length, usually with a 24" wide rectangular chase or duct opening at the centerline.

**Web** A vertical or inclined member connecting the top and bottom chords of a truss.





**MiTek Industries, Inc.**

**14515 N. Outer Forty • Chesterfield, MO 63017**

**800.325.8075 • Fax 314.434.5343**

**[www.mitek-us.com](http://www.mitek-us.com)**

©MiTek Holdings, Inc. All rights reserved